



Data Sheet

Customer: _____

Part No: _____

CL-SP172IR-940-02

Sample No: _____

Description: _____

2012 SMD 940nm IR Sensor

Item No: _____

Customer			
Check	Inspection	Approval	Date

Features

1. Outline Package 1.6x0.8x0.6mm
2. Emitted Color: non-luminance
3. Lens Appearance: Water Clear
3. Comply with RoHS
4. PACKAGE: 4000PCS / REEL.

Applications

1. Applicable to all kinds of mechanical keyboard launch requirements
2. Suitable for all kinds of infrared transmitting and receiving equipment
3. Infrared remote control transmitter is suitable for all kinds of electronic products
4. Applicable to all kinds of small household electrical appliance products for reflection application

Package Outline Dimensions

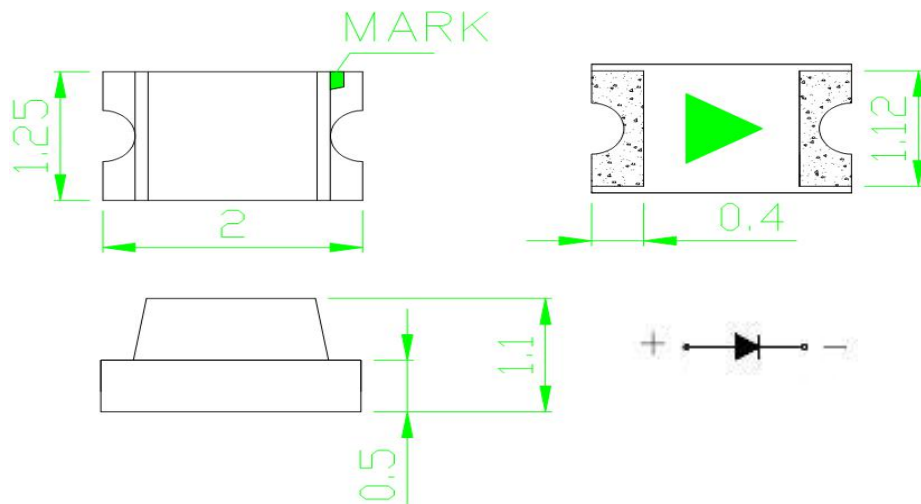

NOTES:

1. All dimensions are in millimeters (inches);
2. Tolerances are $\pm 0.2\text{mm}$ (0.008inch)

Absolute maximum ratings at Ta=25°C

Parameter	Symbol	Value	Unit
Power dissipation	Pd	20	mW
Forward current	If	60	mA
Reverse voltage	Vr	5	V
Operating temperature range	Top	-30 ~+85	°C
Storage temperature range	Tstg	-40~+100	°C
Soldering Temperature	Tsol	Max.260°C for 3 sec Max.	
Peak pulsing current	Ifp	100	mA
Electrostatic Discharge	ESD	2000(HBM)	V

NOTE: IFP Conditions: Pulse Width \leq 10msec. and Duty cycle \leq 1%.

Electrical-optical characteristics at Ta=25°C

Parameter	Test Condition	Symbol	Value			Unit
			Min.	Typ.	Max.	
Forward voltage	If=20mA	VF	1.0	1.2	1.5	V
Emission intensity	If=20mA	Ee	5	10	15	mW/sr
Firing angle	If=20mA	120 1/2	--	120	--	Deg
emission wavelength	If=20mA	λ D	--	940	--	nm
Transmit bandwidth	If=20mA	λ	35	45	55	nm
Reverse current	Vr=5V	IR	--	--	2	μ A

NOTE:

1. Emission intensity tolerance \pm 10%
2. Tolerance of forward voltage is \pm 0.05V
3. Emission wavelength tolerance

Typical optical characteristics curves

Fig.1 Forward Current vs Ambient Temperature

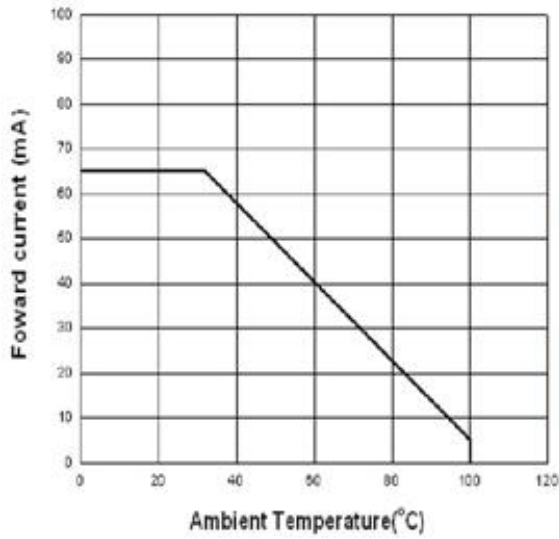

Fig.2 Spectral Sensitivity

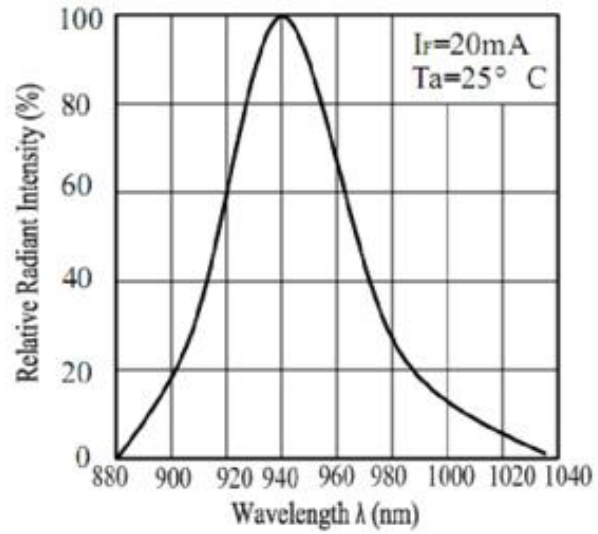

Fig.3 Relative Intensity vs. Forward Current

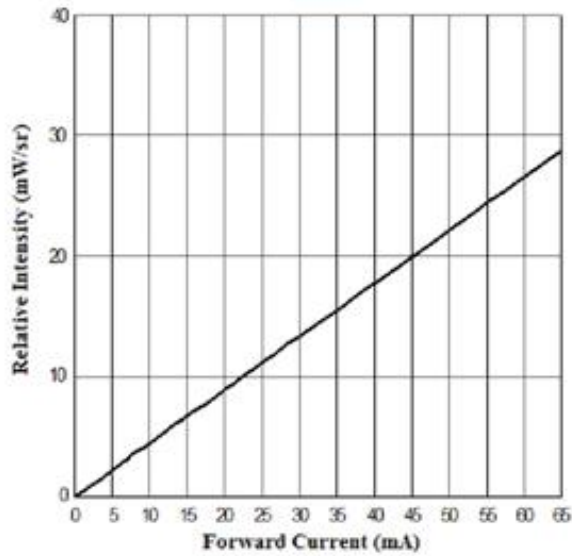

Fig.4 Forward Current vs. Forward Voltage

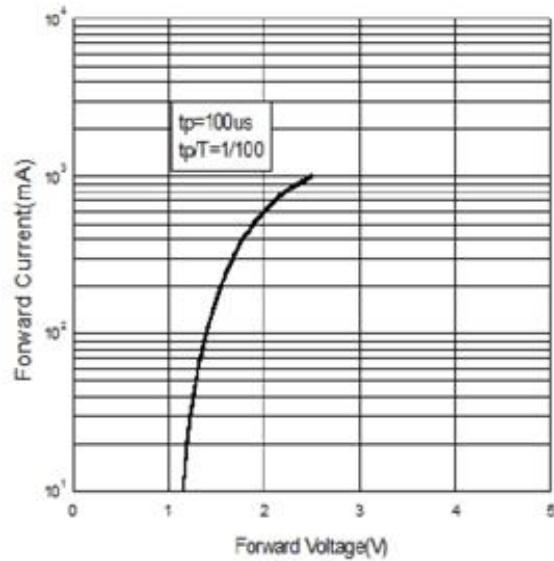
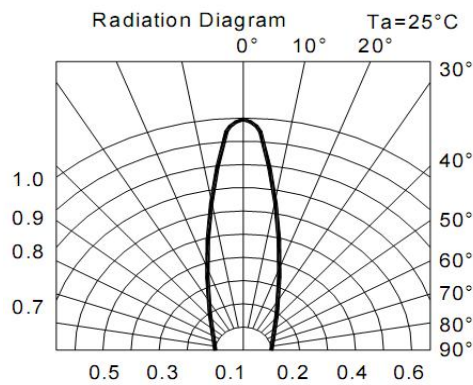

Fig.5 Relative Radiant Intensity vs. Angular Displacement



RELIABILITY

(1) Test Items and Results

NO.	Test Item	Reference Standard	Test Conditions	(Hours/Cycles)	Sample	Number of Damaged
1	Temperature Cycle	JEITA ED-4701	-40 °C - 25 °C - 100 °C - 25 °C 30min 5min 30min 5min	100 Cycles	50	0/50
2	Thermal shock	MIL-STD-202G	-40°C ~ 100°C 15min 15min	500 Cycles	50	0/50
3	High Temperature Storage	JEITA ED-4701 200 201	Ta=100°C	1000 Hours	50	0/50
4	Low Temperature Storage	JEITA ED-4701 200 201	Ta=-40°C	1000 Hours	50	0/50
5	Room Temperature Life Test		Ta=25 ± 5°C IF=20mA	1000 Hours	50	0/50
6	High Temperature High Humidity Life Test		Ta=60°C RH=85% IF=20mA	1000 Hours	50	0/50
7	Solderability (Reflow Soldering)	JEITA ED-4701 300 303	Tsol=235°C ± 5°C, 5sec (Using Flux, Lead Solder)	1 time, 5sec	10	0/10
8	Resistance to Soldering Heat (Reflow Soldering)	JEITA ED-4701 300 301	Tsol=250°C, 10 sec Pre Treatment: 35 °C 95% RH96 Hrs	2 time, 10sec	10	0/10

The above test items such as differences or special customer specific requirements according to the actual situation in accordance with the requirements of customers to try the requirements with the customer, the customer is not required by our test standard test. Different products using different current test

Cautions

(1) Soldering Conditions

Number of reflow process shall be less than 2 times and cooling process to normal temperature is required between first and Second soldering process.

(Recommended soldering conditions)

(Lead Solder)

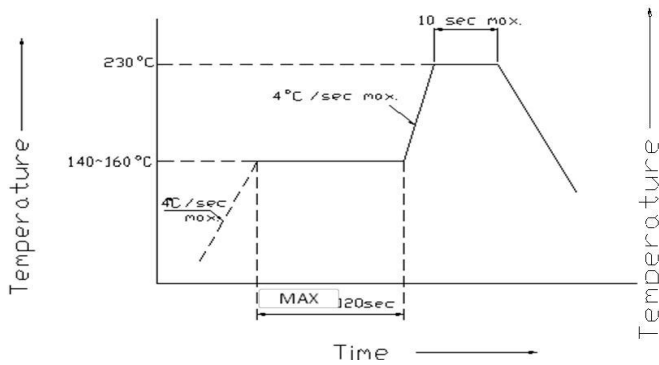

(Lead-Free Solder)

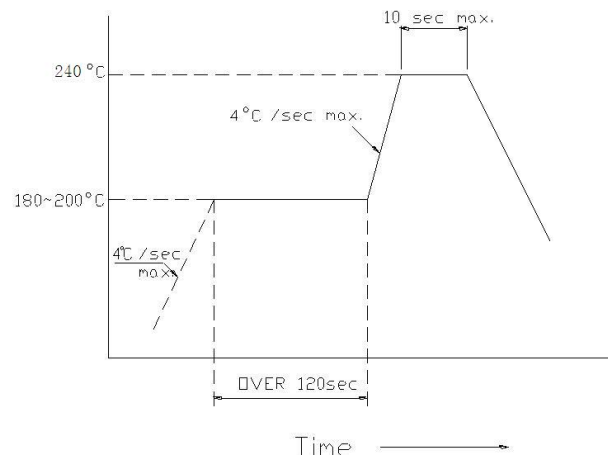

Recommended Soldering Pattern

(Units : mm)

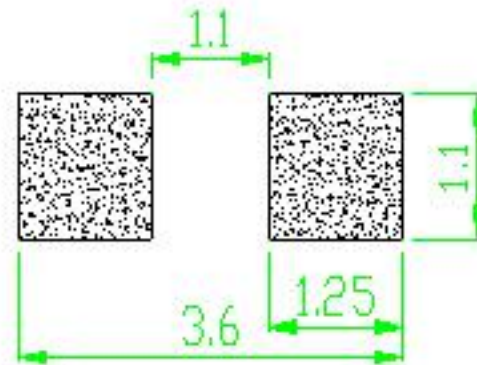

(2) Static Electricity

It is recommended that a wrist band or an anti-electrostatic glove be used when handling the LEDs.

All devices, equipment and machinery must be properly grounded.

Damaged LEDs will show some unusual characteristics such as the forward voltage becomes lower, or the LEDs do not light at the low current. Criteria : ($V_F > 2.0V$ at $I_F=0.5mA$)

(3) Moisture Proof Package

It is recommended that moisture proof package be used .

(4) Cautions:

4.1.

Please check if there is air leak before opening the package, if so, please return the goods back to take drying process for later using.

4.2

Products can be used within 15days after packaging, after that, they must be:

4.2.1

Soldered within 24 hrs

4.2.2

Used in the condition: $30^{\circ}C$ within and 60%RH below

4.2.3

Stored in 30%RH for moisture below.

4.3.

Products cannot be used for and over 15days after being packaged unless opening the package and take drying our process in $85^{\circ}C/6H$.

4.4.

Products not be used for or over 60days after being packaged please return back to take drying out and packaging process for forward using.

4.5.

Products not be used after opening the package need to be dried out for $85^{\circ}C/6H$

PACKAGING

The LEDs are packed in cardboard boxes after taping.

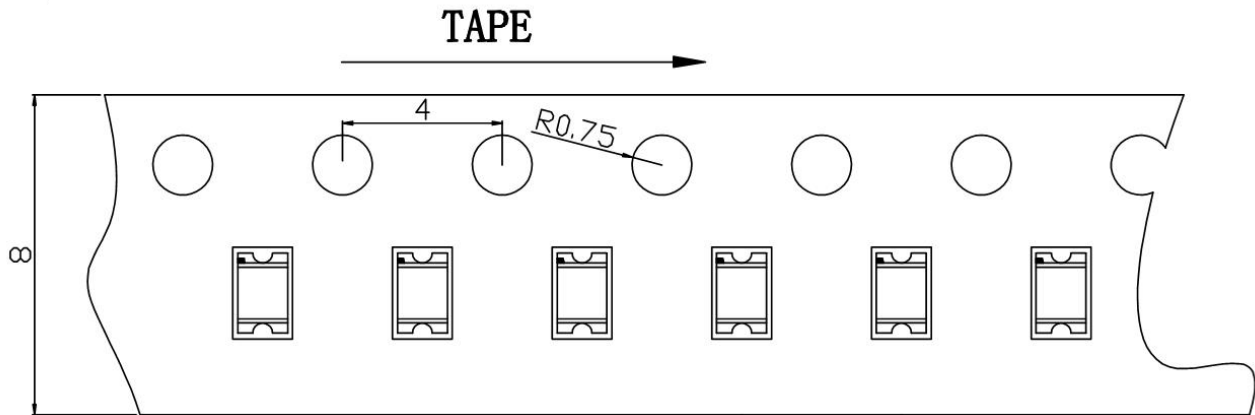

Package: 3000 pcs/reel

Reel Dimensions

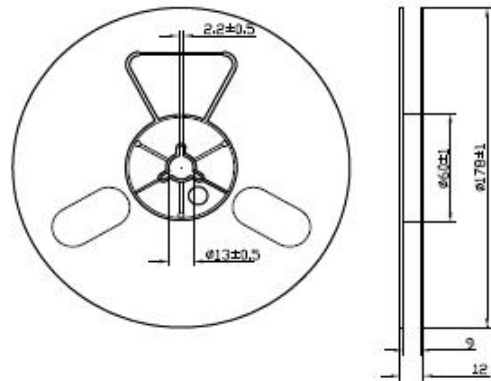

Moisture Resistant Packaging

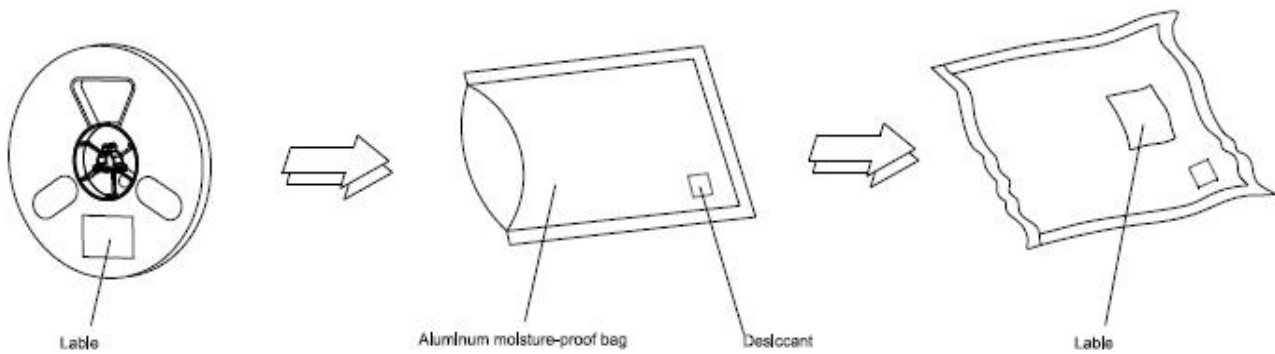

Note: The tolerances unless mentioned is ± 0.1 mm, Unit: mm